

2/2-way-mini Solenoid Valve



- Compact design
- Low electrical power consumption
- Short response times
- Hermetically sealing isolating diaphragm
- Non-metallic valve internals

Type 117 is a normally-closed direct-acting plunger-type solenoid valve with PTFE-coated diaphragm. The diaphragm isolates the fluid from the solenoid system.

When deenergized (in circuit function A) the valve is closed by spring action. When energized, the solenoid armature is drawn in 2/2-Way, G 1/8, UNF 1/4-28 Fluid Control Systems against a spring to open the valve. The solenoid epoxy encapsulation efficiently dissipates the heat generated by the coil.

Circuit function A

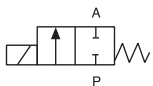

A 2/2-way
valve NC

Technical data	
Body material	ETFE (TEFZEL)
Seal material	PTFE with EPDM - PTFE with FKM
Media	PTFE/EPDM: alkalis, acids to medium concentration, washing- and bleaching lyes PTFE/FKM: oxydizing acids and substances, salt solutions, oils and waste gases
Medium temperature	-10 ... +70 °C
Max. ambient temperature	max. +55 °C
Max. viscosity	21 mm ² /s
Response times	opening approx. 20 ms closing approx. 20 ms
Installation	as required, but preferably with solenoid system upright
Operating voltages	12 V DC, 12 V DC battery, 24 V DC, 24 V UC, 220-230 V UC
Voltage tolerance	± 10 %
Power consumption	4 W
Duty cycle	100 % continuously rated
Cycling rate	up to 300 c.p.m.
Protection class with cable plug	IP 65
Electr. connection	Delivery standard: Cable plug DIN 43 650 Form B, 0-250 V. Flying leads 300 mm length

Materials

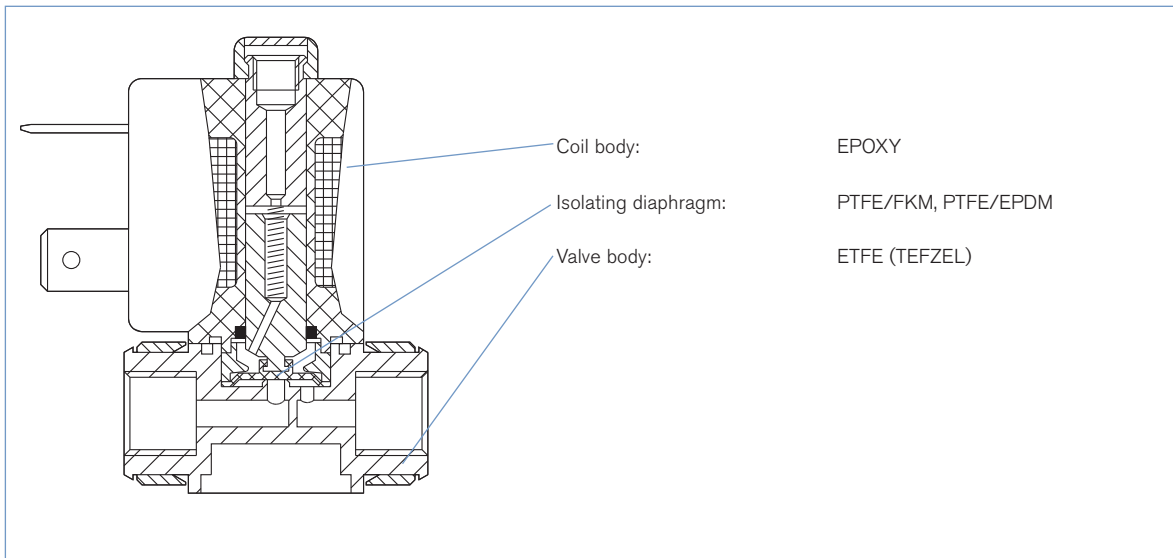

Ordering chart for valves (other versions on request)

All valves with ETFE-body (TEFZEL); without cable plug (see accessory); PTFE-seat seal with EPDM or FKM

Circuit function	Orifice [mm]	Port connection	Kv value water [m ³ /h]	Pressure range [bar]	Seal material	Voltage/ Frequency [V/Hz]	Item no.
A	1.2	G 1/8	0.045	0 - 2	PTFE/FKM	24/UC	064 929
A	1.6	G 1/8	0.06	0 - 1.5	PTFE/EPDM	24/DC	057 606
						24/UC	058 206
						12 V/DC Batterie	085 529
					PTFE/FKM	24/DC	056 664
						24/UC	041 763
						220-230/UC	057 839
A	2.0	G 1/8	0.09	0 - 1.0	PTFE/EPDM	24/DC	043 698
						24/UC	068 170
						220-230/UC	021 301
					PTFE/FKM	24/DC	040 947
						24/UC	058 062
						220-230/UC	021 186
A	2.4	G 1/8	0.10	0 - 1.0	PTFE/EPDM	24/DC	056 878
						24/UC	021 352
						220-230/UC	022 140
						PTFE/FKM	12/DC
					PTFE/FKM	24/DC	056 535
						24/UC	047 399
						220-230/UC	056 630

■ NPT version on request

Ordering chart Accessory (Cable plug acc. to DIN EN 175301-803 Form B (previously DIN 43650))

	Circuit	Voltage / frequency	Item no.
	none (standard)	0 - 250 V AC/DC	423 845
	with LED	24 V UC	423 849
	further versions	see datasheet type 2507	

The delivery of a cable plug includes the flat seal and the fixing screw. For other cable plug versions acc. to DIN EN 175301-803 Form B (previously DIN 43650), see data-sheet Type 2507.

Dimensions [mm]

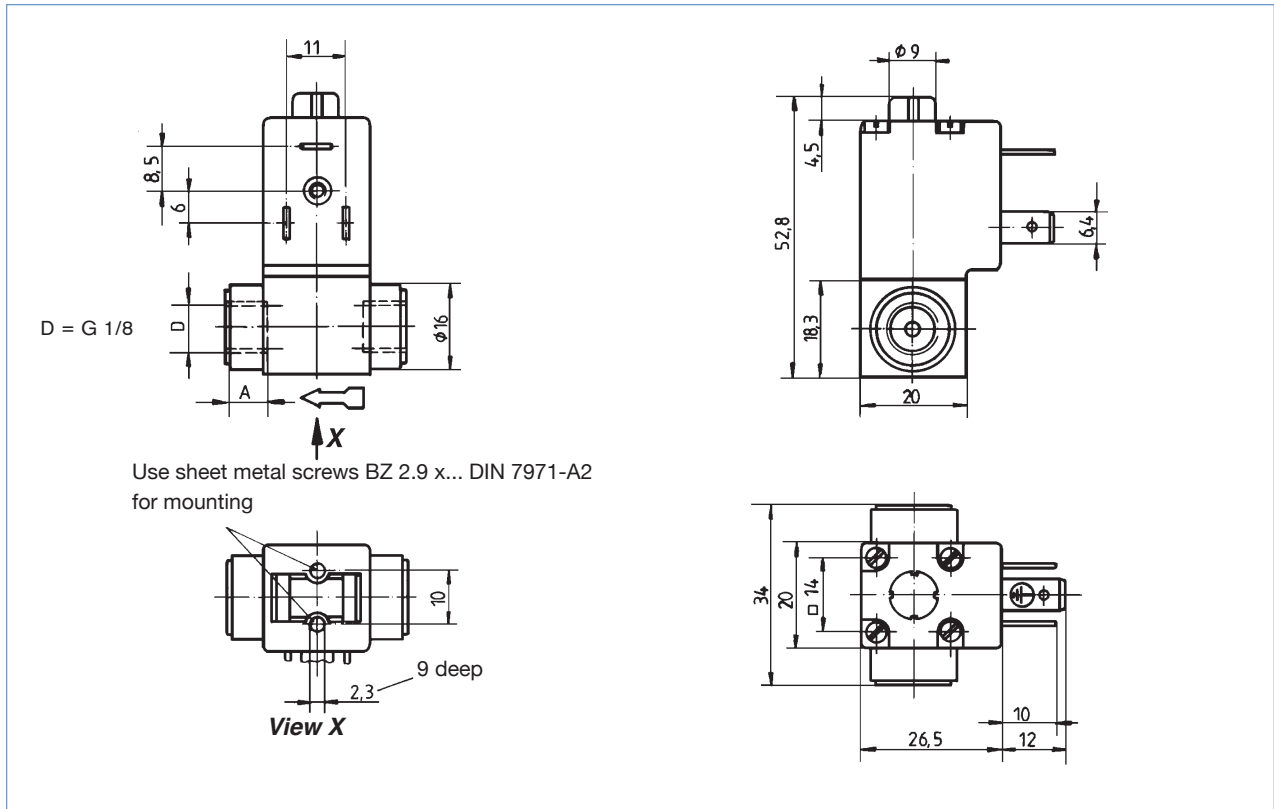

DTS 1000010903 EN Version: D Status: RL (released | freigegeben | valide) printed: 24.10.2016

To find your nearest Bürkert facility, click on the orange box → www.burkert.com

In case of special application conditions, please consult for advice. Subject to alterations © Christian Bürkert GmbH & Co. KG 1001/1_EU-en_00891600